



## OPTIMISED TOOL FOR THE MEASUREMENT OF WINDING RESISTANCES ON POWER TRANSFORMERS

Marc Müller<sup>1</sup>

<sup>1</sup>Haefely Test AG, Basel, Switzerland

\*Email: mueller.marc@haefely.com

**Abstract:** The topic of this paper is the analysis of the fundamentals of the winding resistance measurement and their application for the development of an optimized tool. The ultimate goal is to create a portable device, which measures a complete transformer the fastest and easiest way possible. The influence of the charging voltage and the measuring current on the measuring time has to be analyzed. Another important issue is the stabilization time on low ohmic delta windings. Further, testing time can be reduced by introducing a demagnetization feature, which eliminates the need of applying high voltage AC after a DC resistance test. Finally, the implementation of the optimized tool is presented with its efficient connection scheme and the multi-channel architecture.

### 1 INTRODUCTION

Fast, efficient and accurate measurement of winding resistances on large power transformers creates several difficulties.

Long charging and discharging times, unstable values on closed delta winding systems due to long stabilization times, inaccurate temperature measurements for resistance correction, residual magnetism and its unwanted effects, inefficient connection and disconnection of the measuring equipment are just some of the difficulties to deal with.

The paper describes an integrated, mobile instrument developed to speed up the stabilisation time when supplying DC to a transformer winding by an intelligent magnetic-flux optimised charging. With example diagrams of various transformers the charging and stabilisation effects are shown.

After applying DC to a transformer, the core remains magnetized. This can cause problems for further measurements or reconnecting the transformer to the grid. Thus, an integrated, low voltage demagnetization function to bring a power transformer into a defined, demagnetised state will be shown.

Typical problems arising when connecting a measuring system to a power transformer have been solved. In particular these problems are time consumption and faulty connections, which have been solved by a fully integrated connection set and a multiplexing circuit. Error possibilities in setting up the measurement equipment have to be faced and eliminated by offering state-of-the-art graphical, self-explanatory user interfaces with online information about all related values and conditions in an easy and well-arranged way.

### 2 SUPPLY VOLTAGE AND CURRENT

#### 2.1 General measuring principle

Figure 1 shows a schematic of a common winding resistance measurement technique.

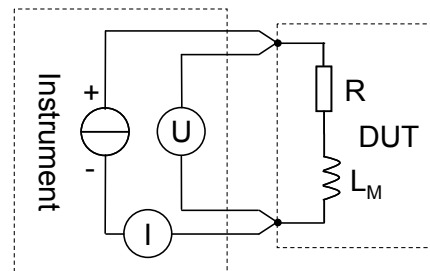

**Figure 1:** Winding resistance measuring principle using a DC power supply

The instrument consists of a programmable power supply, which is normally operated in constant current mode. It is used to supply a user-defined current into the DUT. Additionally, there is a voltage and current measurement unit. Thus, the resistance is calculated according equation (1):

$$R = \frac{U}{I} = \frac{U_R + U_{LM}}{I} = \frac{U_R}{I} + L_M \cdot \frac{dI}{dt} \quad (1)$$

#### 2.2 Magnetizing inductivity L<sub>M</sub>

Also, Equation 1 shows the main difference between a normal and a winding resistance measurement. There is a large inductance in series with the resistance of interest. This inductance is typically in the range of L<sub>0</sub> = 0.1H to



5000H. In figure 2, the current dependency of the magnetizing inductivity is depicted.

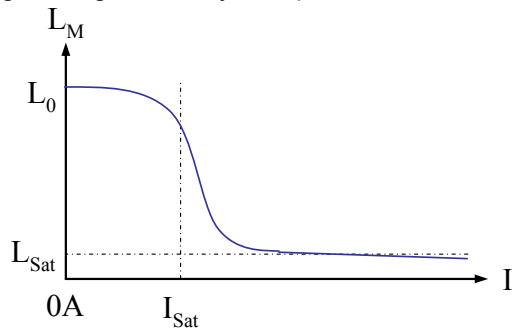

**Figure 2:** Inductance of a transformer core  
By rule of thumb the saturation current can be expressed in terms of the no load current  $I_0$ :

$$I_{Sat} \approx 2 \cdot I_{0,RMS} \quad (2)$$

Because of the large magnetizing inductivity of the transformer, the measuring current can not be applied instantaneously. The current can only change according to equation (3):

$$\frac{dI}{dt} = \frac{U_{LM}}{L_M} \quad (3)$$

For a given transformer, the rate of change of the measuring current depends only on the voltage applied to the magnetizing inductivity  $L_M$ . Current charging and discharging time depends mainly on the maximally available supply voltage. Figure 3 compares two charging processes using a voltage of either 50V or 100V.

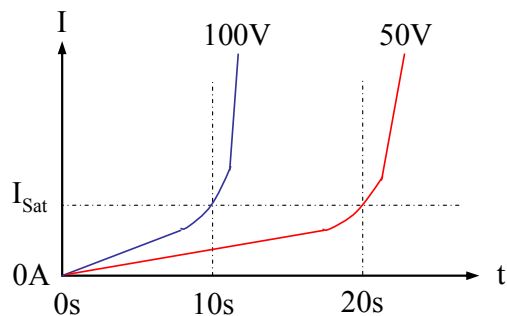

**Figure 3:** Transformer charging and discharging using constant voltage

Also, Figure 3 illustrates, that it takes longer to reach a higher current, which is inherently clear. But if the current is higher than the saturation

current of the inductance, there is no relevant difference anymore.

Basically we can state the following rules:

- The higher the supply voltage, the faster the current can be charged or discharged.
- The higher the selected current, the longer it takes for the current to be charged or discharged.

### 2.3 Power Supply stability

It is common practice to use off the shelf power supplies to supply the measuring current to the transformer. The feedback current control loop of such devices is not designed for high inductive loads. Therefore the output voltage of these devices oscillates depending on the load. Figure 4 shows a case with a damped oscillation, where the supply takes a long time to stabilize. It is also possible, that the oscillation is not damped and no stable measurement value is reached.

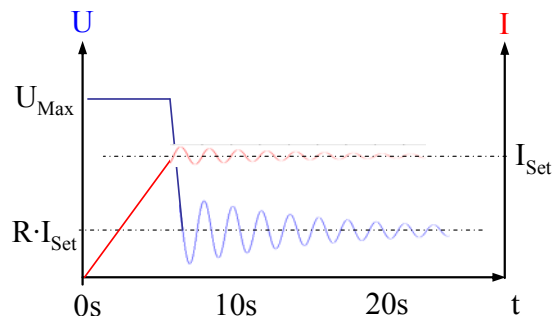

**Figure 4:** Transient oscillation of a power supply in constant current mode with a high inductive load

Increasing the measurement current over the saturation level leads to a significantly lower magnetizing inductivity. This lower inductivity helps the standard power supply to stabilize faster. This is one reason why people often believe, that a high measurement current is necessary to get fast stabilisation.



**2.4 Delta winding considerations**

Figure 5 shows a common transformer configuration with a delta connected winding on the low voltage side.

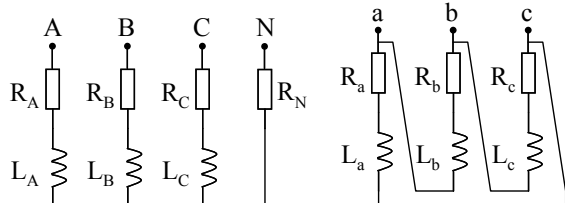

**Figure 5:** Example transformer YNd11

The common method for measuring the winding resistance of a delta connected winding is illustrated in figure 6. The example shows a measurement at the transformer terminals 'a' to 'b'.

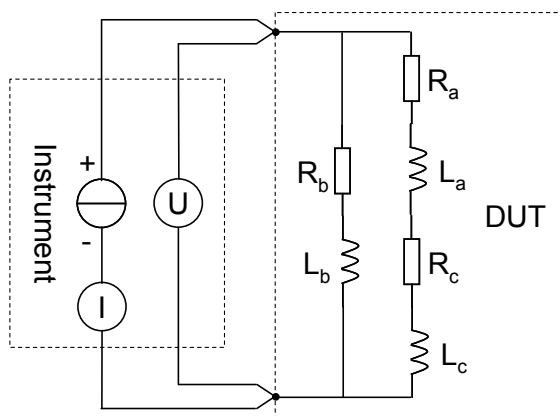

**Figure 6:** Winding resistance measurement on a delta winding

When we apply a voltage between terminals 'a' and 'b', a current starts to flow. This current splits between the two depicted branches.

$$I(t) = I_b(t) + I_a(t) \tag{4}$$

During charging, the current distribution between the two branches is dominated by the ratio of the magnetizing inductances and not by the ratio of the resistances. During and directly after charging, the current distribution is as follows (because the three inductivities are not equal):

$$\frac{I_b}{I_a} = \frac{L_a + L_c}{L_b} \neq 2.0 \tag{5}$$

But in steady state the current distribution will be according equation 6 (for  $R_a \approx R_b \approx R_c$ ):

$$\frac{I_b}{I_a} = \frac{R_a + R_c}{R_b} \approx 2.0 \tag{6}$$

Using the method depicted in figure 6, the measured resistance value will only be correct when reaching steady state. By introducing a virtually circulating current, equation (4) can be rewritten as follows (where  $I_a'$  and  $I_b'$  are the steady state currents):

$$I(t) = (I_b' + I_{Circle}(t)) + (I_a' - I_{Circle}(t)) \tag{7}$$

Steady state is reached when  $I_{Circle}$  decayed to zero. The decay is an exponential process characterized by the passive components involved and the initial circulating current  $I_{Circle0}$ . It can be described as follows:

$$I_{Circle}(t) = I_{Circle0} \cdot e^{-\frac{t}{\tau}} \tag{8}$$

$$\tau = \frac{L_a + L_b + L_c}{R_a + R_b + R_c} \tag{9}$$

This leads to another problem for winding resistance measurement. When the delta winding is on the low voltage side of a large generator transformer, the winding resistance is typically very small (<10mΩ). According to equation (9), this leads to a large time constant for the circulating current to go to zero. Measurement stabilization times from several minutes up to one hour can be observed on large transformers.

One way to speed up this stabilization time is to decrease the magnetizing inductivity of the transformer. This can only be done by saturating the transformer core. On low voltage windings of large power transformers, the saturation current can easily exceed 10A to 100A. Which is the reason why people often want to have high current (>50A) measuring devices.



**3 FLUX OPTIMIZED YN-DELTA METHOD**

**3.1 Background**

This section describes another method to decrease the stabilization time on a low ohmic delta winding. The goal of this method is to reduce the magnetizing inductivity by saturating the core, too. But this method uses the high voltage winding to saturate the core, because the saturation current on the high voltage side can be significantly lower than on the low voltage side (depending on the turns ratio):

$$I_{Sat}^{HV} = I_{Sat}^{LV} \cdot \frac{N_2}{N_1} \quad (10)$$

Figure 7 shows the relative steady state flux distribution in the transformer core, when applying a current  $I_2$  from 'a' to 'b' on the transformer depicted in figure 5. Since the ratio of the currents  $I_b$  and  $I_a$  is about 2, also the ratio of the fluxes in the corresponding core legs is about 2.

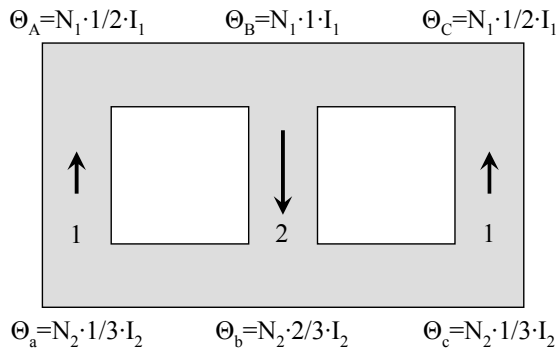
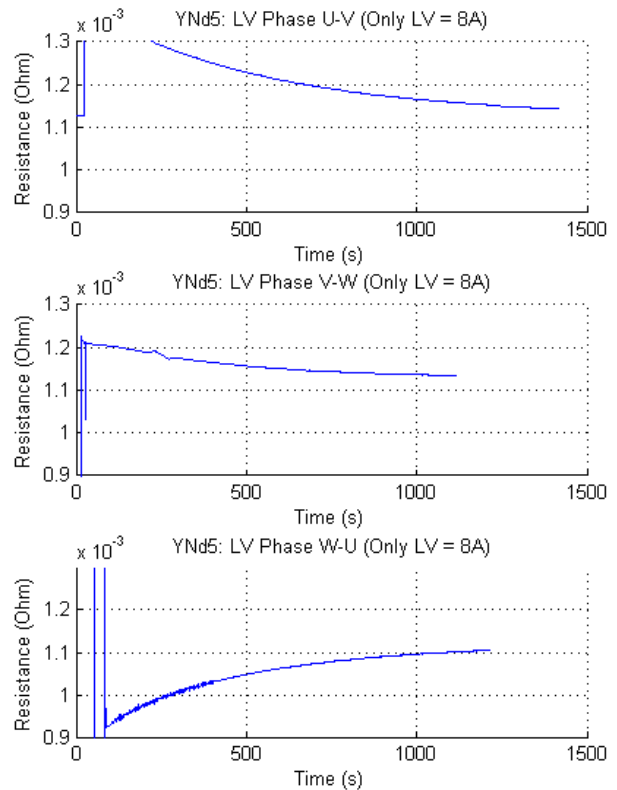

**Figure 7:** Flux distribution when measuring LV b-a

As already mentioned, the core gets saturated by injecting another current into the high voltage winding, which has much more turns ( $N_1$ ) than the low voltage winding ( $N_2$ ). The key of the described method is that the flux distribution generated by the high voltage winding matches the flux distribution generated by the low voltage side. Figure 7 also show the electromotive forces  $\Theta$  generated by each winding, which indicate the current distribution in the windings.

**3.2 Experimental Results**

Tests with the described method have been performed on an 1100MV generator transformer (YNd5, 27kV to 420kV step-up) to compare the performance of the different methods. The nominal resistances of the phases on the low voltage side are about 1.12mΩ. The saturation currents are  $I_{Sat1} \approx 0.9A$  and  $I_{Sat2} \approx 12A$  Figure 8 illustrates the stabilization time of the resistance reading, when supplying 8A to the low voltage winding only.



**Figure 8:** Resistance measurement on a large generator transformer (YNd5, 1100MVA) using the common method with  $I_2 = 8A$  (Only LV)

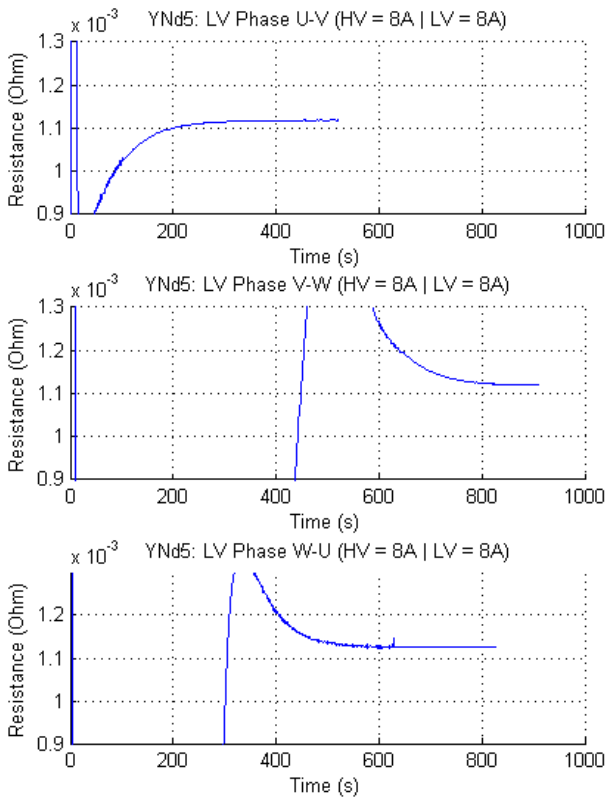

**Figure 9:** Resistance measurement on a large generator transformer (YNd5, 1100MVA) using the flux optimized YN-Delta method with  $I_1 = 8A$  (HV) and  $I_2 = 8A$  (LV)

And figure 9 illustrates the stabilization time of the resistance reading, when the flux optimized YN-Delta method is used with 8A on the high voltage side and 8A on the low voltage side.

In both cases the measurement current injected on low voltage side is 8A, which is smaller than the saturation current  $I_{Sat2} \approx 12A$ . But the stabilization time with the traditional method is much longer (25 to 30 minutes) than with the optimized method (6 to 14 minutes).

By increasing the measuring current of the traditional method to 100A, stabilization times between 7 and 23 minutes have been achieved.

On this particular transformer the flux optimised method performed even better than the classical method using high current.

The conclusion is that even the largest transformers can be measured within an acceptable time using a non saturating current on the low voltage side.

**4 DEMAGNETIZATION**

**4.1 Background**

After disconnecting a transformer from the grid or performing a winding resistance measurement with direct current, the transformer core will be magnetized. Figure 10 shows a transformer core hysteresis curve with a possible magnetization  $M_0$ .  $M_0$  can be anywhere on the y-axis within the hysteresis loop.

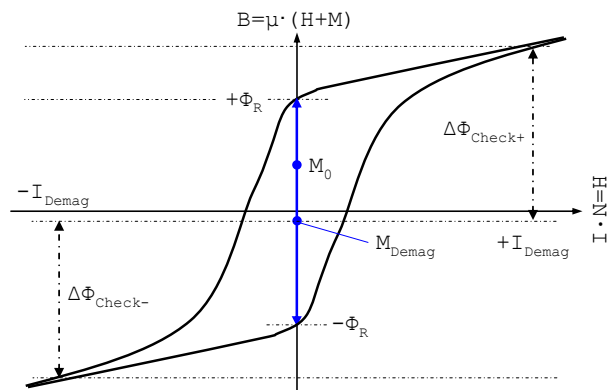

**Figure 10:** Hysteresis loop of the magnetizing inductance of a transformer

The magnetization  $M_0$  can influence various measurements like turns ratio or frequency response. For these measurements the magnetization should be  $M_0 \approx 0Am^{-1}$ , otherwise the results can be wrong or not comparable. Further, connecting a magnetized transformer to the grid can cause high inrush currents.

The common method to demagnetize a transformer core is to apply nominal AC voltage to the transformer and slowly decrease its amplitude to zero. But this method requires a very large and not portable controllable AC voltage source.



## 4.2 Demagnetization Procedure

The invented demagnetization procedure consists of two sub procedures and requires only a low voltage power supply (<100V):

**Analyzing the transformer:** The hysteresis loop of the transformer is calculated using a special algorithm. The algorithm comprises the injection of a current  $I_{Demag}$  to the transformer and the measurement of the response of the transformer.

**Iterative reduction of the remaining magnetization:** The current core flux is continuously calculated and an algorithm is used to determine how to regulate the voltage supply connected to the transformer. Since it is an iterative algorithm, multiple cycles are necessary to reach a sufficiently low residual magnetization.

## 4.3 Experimental Results

To verify the demagnetization procedure  $\Delta\Phi_{Check+}$  and  $\Delta\Phi_{Check-}$  have been measured after demagnetizing the DUT. If the transformer is demagnetized properly, then  $M_{Demag} \approx 0$ , which leads to  $\Delta\Phi_{Check+} \approx \Delta\Phi_{Check-}$  (refer to figure 10).

- **DUT I:** Yy0    12.5MVA    49kV | 16.9kV
  - Analyze with  $I_{Demag} = 5A$      $\Phi_R = 160.2Vs$
  - Check after demagnetization     $\Delta\Phi_{Check+} = 318.8Vs$   
 $\Delta\Phi_{Check-} = 317.6Vs$
  - Check when magnetized     $\Delta\Phi_{Check+} = 150.5Vs$   
 $\Delta\Phi_{Check-} = 469.3Vs$
- **DUT II:** Dyn5    160kVA    4.25kV | 1kV
  - Analyze with  $I_{Demag} = 5A$      $\Phi_R = 9.44Vs$
  - Check after demagnetization     $\Delta\Phi_{Check+} = 19.8Vs$   
 $\Delta\Phi_{Check-} = 19.3Vs$

On both example DUTs the transformer core is demagnetised properly. The volt-seconds applied to reach a positive or negative current  $I_{Demag}$  is the same in both cases after demagnetization. On the DUT I we can clearly see the misbalance of the applied volt-seconds when the core is magnetized.

## 5 DUT CONNECTIVITY

This chapter deals with the problems arising when connecting a measuring system to a power transformer. Problems like time consumption and faulty connections are discussed.

The connectivity of a traditional high current winding resistance measurement device with two channels and one current supply is depicted in figure 11.

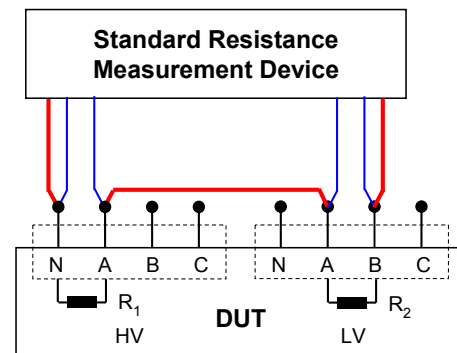
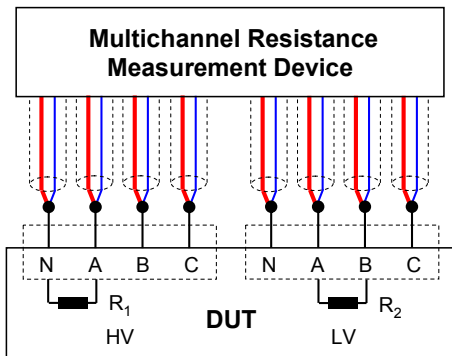

**Figure 11:** Traditional winding resistance measurement with two channels

A total amount of 7 cables is needed to perform this measurement: Two supply cables, one jumper cable and four sense cables to measure the voltage drop at the DUT. With the traditional method a maximum of two resistances can be measured, before one has to reconnect the DUT. One on the low voltage side and one on the high voltage side. The user of the device has to figure out the right way to connect by him self. This increases the probability of a faulty connection.

With a multichannel topology the user has to connect the DUT only once. As illustrated in figure 12, for each bushing on the transformer there is exactly one clamp. Thus, no reconnection is required at all. This reduces the probability of a faulty connection to a minimum.

To reduce the amount of cables and clamps required to perform a full connection, Kelvin clamps are being used. Kelvin clamps have two electrically isolated jaws, each connected to a separate wire. This makes it possible to connect the complete transformer with only 8 Kelvin clamp cable sets. The results are reduced connection and disconnection times.



**Figure 12:** Multi-channel winding resistance measurement device

**6 OPTIMIZED TOOL**

The key to a portable and optimized winding resistance measurement device is to reduce the maximally needed supply current. Because a high supply current results in larger and heavier power supplies, connectors, cables and switching matrices. The switching matrix is needed to realize the multichannel concept of the device.

The two key elements necessary to reduce the maximally needed measuring current have already been introduced:

- A power supply with a specially designed control loop for high inductive loads.
- A method to deal with the long stabilization times when measuring a low ohmic delta winding (e.g. large generator transformers).

This leads to an instrument which combines all the features presented in this paper. Figure 13 shows a block schematic of the proposed instrument. The system consists of two voltage and current controlled power supplies, which can be connected in any configuration to the DUT. This is realized using a power relay matrix. Additionally there are two voltage measurement units, which can be connected in any configuration to the DUT. This is realized using a small signal relay matrix. Further there is also a tap changer control circuit and a temperature measurement unit.

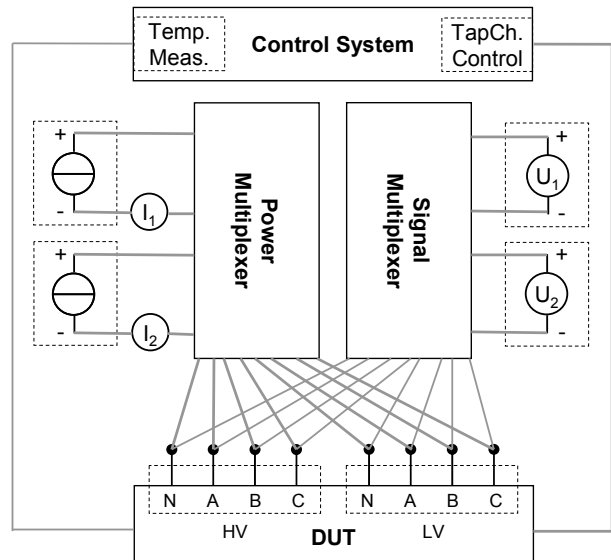

**Figure 13:** Block Schematic of the Instrument

With this instrument a complete transformer can be measured fully automatic. This includes all three phases on the high voltage side and low voltage side. Additionally, the device can cycle through all taps automatically and correct all resistance values to a reference temperature without user intervention. Figure 14 shows a comparison between the measurement procedures of a three phase transformer with a remote controlled tap changer. The classical procedure requires repetitive user interactions. The user has to write down measurement values, operate the tap changer and reconnect the measuring cables. Using the optimized tool, user interaction is reduced to the initial connection and setup of the device. This helps to reduce the overall testing time and does not allocate user resources during the measurement.

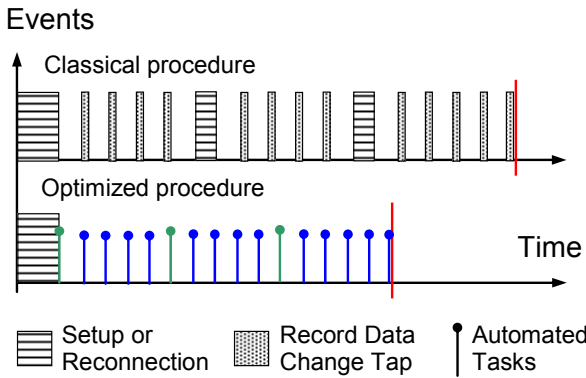

**Figure 14:** Comparison of the measurement procedure for a three phase transformer with 5 remote controlled taps

## 5 CONCLUSIONS

This paper demystifies effects observed when measuring winding resistances on various types of transformers. The basics of winding resistance measurement are commonly not well known. Also, this paper introduces theoretical concepts such as the flux optimized measuring method or the demagnetization procedure. These concepts have been verified by experimental results.

Based on the research presented an optimized and flexible hardware with a complex control system has been developed.