



OT 257 AC

Operating Terminal for High Voltage AC System Control



The operating terminal OT 257 is our state-of-the art product, which allows comfortable and flexible control of high voltage test transformer or resonance test systems.

The Industrial PC based control system is specifically designed for the needs of HV testing. This control system is supplied with a Windows based control software package of which the development is based on the experience of three generations of AC test system controls. The system's hardware has an EMC hardened design for safe use also in the most electrically noisy areas.

Active and passive safety is implemented into the system in form of independent external emergency switches, software watchdogs, graphic symbols and status information for fast understanding.

A Report File can be used for further data processing. This ASCII format File can be imported into most Data processing applications and databases.

With the advanced software "Sequence", it is possible to create complex test cycles and with the option "Remote", the AC test system can be controlled by any host computer.

A full online help is implemented in the software to support the operator.

FEATURES

- **This system controls:** output voltage, regulating voltage and current, rise time, testing time, gap distance, resonance control, history, alarms, trips, grounding, safety, status visualization, sphere gaps, data logging, data storage, status handling, automation, system diagram visualization and online help.
- **Manual operation mode** - with all status information, resonance control, rise time, etc still with full operator control.
- **Free programmable Sequence mode** optimized for automated production testing. A defined test sequence can be set up by the user easily, run by the software and the results are recorded. All test sequences can be recorded and saved for later use or repetition.
- **Full visualization of test system** with measuring values, switch positions, earthing system, alarms and warnings.
- **Integration of external measuring devices** over ActiveX components and adaptation of its measuring values for remote operation and presetting of measuring devices.
- **OLE** interface allows data access from other applications (e.g. Excel, Word, etc.)

BENEFITS

Easy, intuitive understandable and useable graphic user interface (GUI)

Automatic test report generation from the

integrated **Reporting Tool** with user definable layout, logo insertion, etc.

Windows control software with all its advantages of integration, remote control, remote supervision, LAN connection and decentral data-storage.

Easy adaptable to different AC test systems for an easy system upgrade or modernization of all types of AC high voltage test systems.

APPLICATIONS

- Power Cable testing
- Power Transformer testing
- Switchgear testing
- Research & Development
- Universities

a brand of

HAEFELY 



Haefely is a subsidiary
of Hubbell Incorporated.





The software user interface has been designed for easy, intuitive operation. Information (e.g. HV status) is brought to the operator by graphical signs, color bars, pop-up info boxes, animated images and graphic symbols, to ensure that the operator can see the system status and safety related information with one view on the main screen. For further settings, options etc. sub-screens can be opened or pop up when clicking on the related visualization fields.

SOFTWARE FEATURES

Main actions as "Set Ready", HV ON" etc. are accessible over short keys, which also support the user by its visualized status (only active buttons are enabled)



HV status visualization. On one display can be seen what the safety status, the regulating voltage, the output voltage, output current and the limiter settings are.

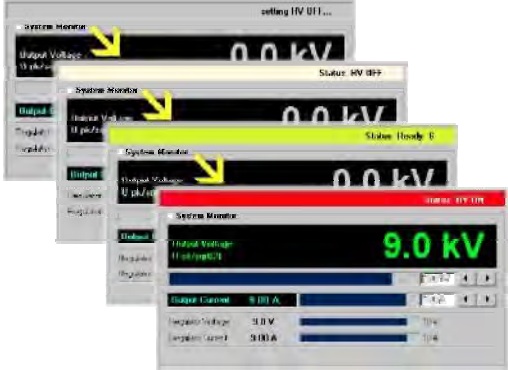

Voltage controls are visualized with images of the actual status (e.g. here the red icon shows that the preset output voltage is reached). Voltage can be controlled manually or fully automatic by the software and adjusted and calculated for actual conditions.

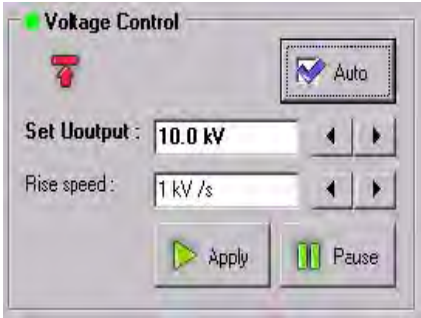

For resonance systems the actual resonance condition is visualized. It can be controlled manually or fully automatic by the software, which adjusts and calculates the actual air gap position.



All system alarms and warnings are collected into one Alarm Monitor. As soon as an event occurs the dialog pops to the front and the actual alarm status is visualized.

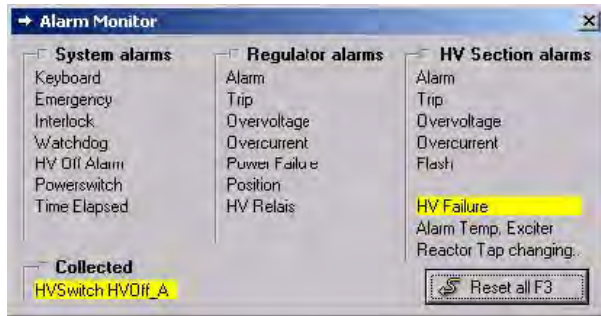

Measured values of external test equipment (e.g. DMI551, TE571, DDX7000, 2877, etc.) can be read-out by this software and will be displayed and reported. The ActiveX feature allows an easy integration of your measuring equipment into the OT 257 control system.

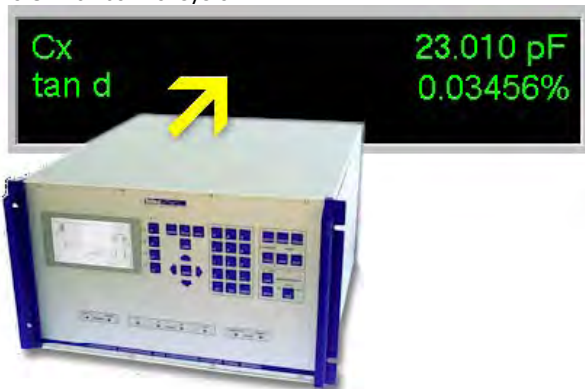

An online help file is accessible. The user is guided through the operating manual via the index and text search option.

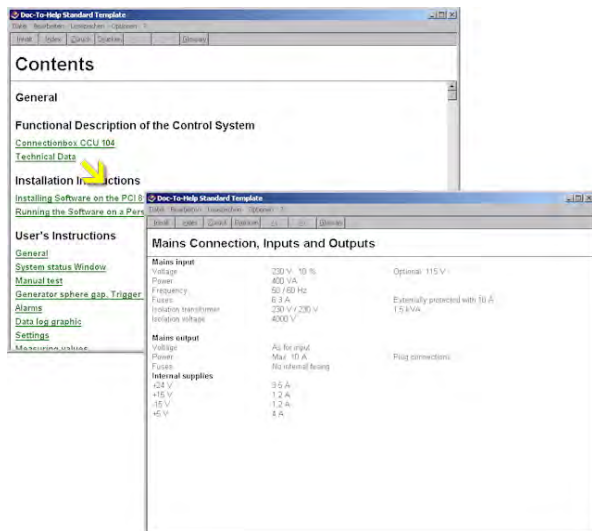

The diagram of the whole AC test system can be shown. All important values; status, switches, safety, earthing, warnings, etc. are visualized at the correct location, which helps for debugging the system in case of a fault.

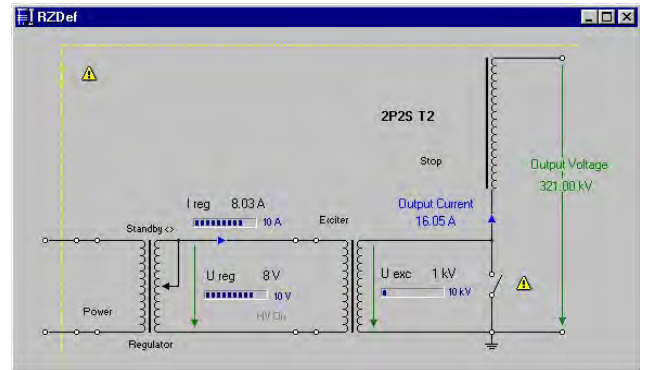

A graphic window displays the output voltage versus testing time. In addition the output current or a measurement of an ActiveX component can be displayed as a function of time or in relation to each other. The measuring curve is displayed by a green line and additionally the maximum (limiter) of the measured value is displayed by a red line.

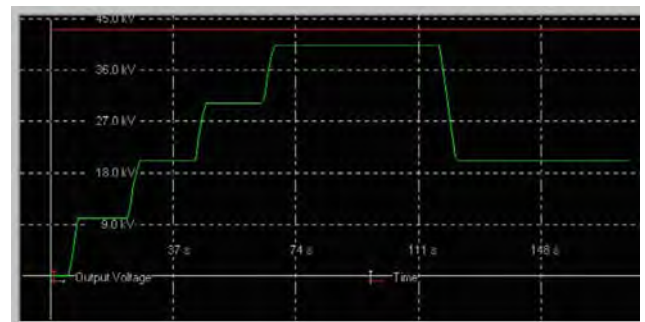

All system settings are accessible via defined folders.

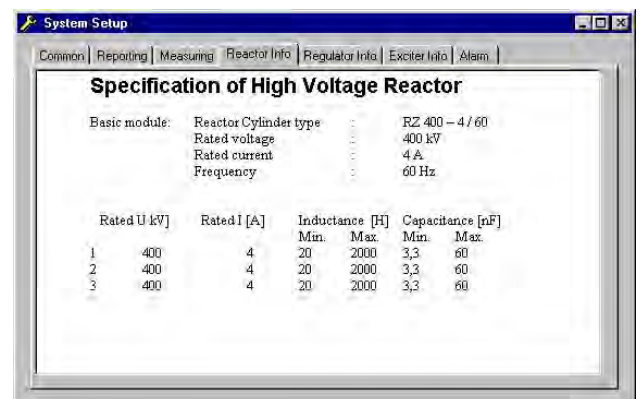

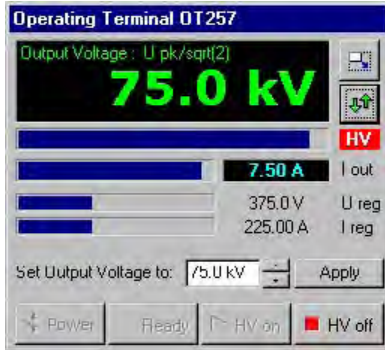

The OT257 main software screen can be minimized to have access to the most important data and controls while working on another application on the same PC.

AUTOMATION

Sequences can be easily programmed by prepared steps and orders. Just select in the pull-down combo what order shall be executed at each step, define the arguments and values for that order and so on – save – run – test and optimize

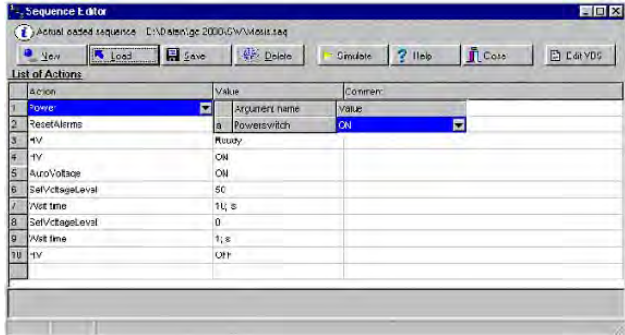

When running the sequence a Supervisor window pops up where you can see all the actual steps, the time and the order in which they will be executed.

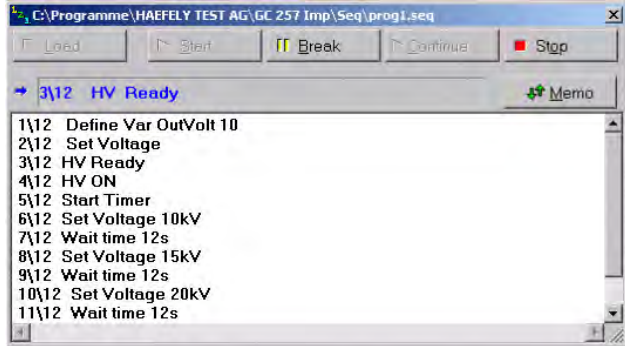

ADDITIONAL FEATURES AND OPTIONS

The software also provides a COM (Component Object Model) interface that allows direct access or remote access via local area network (LAN, company network) for other applications (MS-Excel, MS-Word, etc.). This allows for further processing of the measured data, central storage and easy export of data.

This software can be bound into a host control software, which allows to control the test system with an external customer specific software, either direct or remote via LAN and DCOM (Distributed Component Object Model).

Remote access e.g. for remote system diagnosis, supervision of actual status from remote locations (e.g. for long tests periods) can be done over an additional modem connection and a linking program (PC-anywhere or similar).

REPORTING

The stored data log entries can be selected and a test report can also be produced by the software and send directly to the printer.

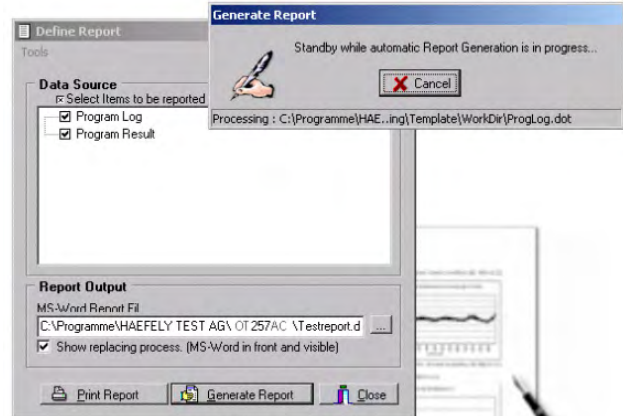

HARDWARE DESIGN

OT 257 AC control system consists of an industrial process computer specifically designed for the needs of HV testing with its peripheral devices as printer, monitor, keyboard and mouse. Furthermore it contains backend interface module inserts and a front-end interfacing box to connect to the AC test system parts.

All back-end parts are normally mounted in a desk console with a 12U mini rack, special shielding against EMC disturbances as well as a power supply are included. The complete system hardware has an EMC tested and hardened design for safe use also in the most electrical noisy areas.

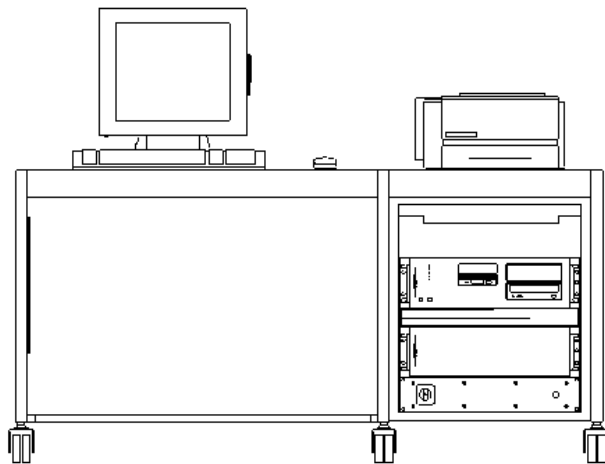

The new standard Haefely desk with mini-rack and electronics inserts. Special desk sizes or racks are available on request.

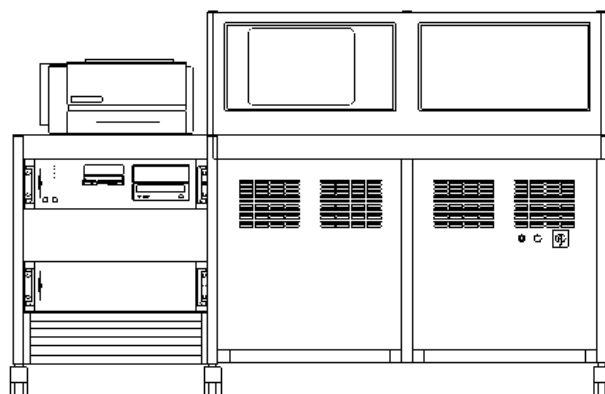

A modernized older Haefely desk design with new inserts and new software

SYSTEM DESCRIPTION

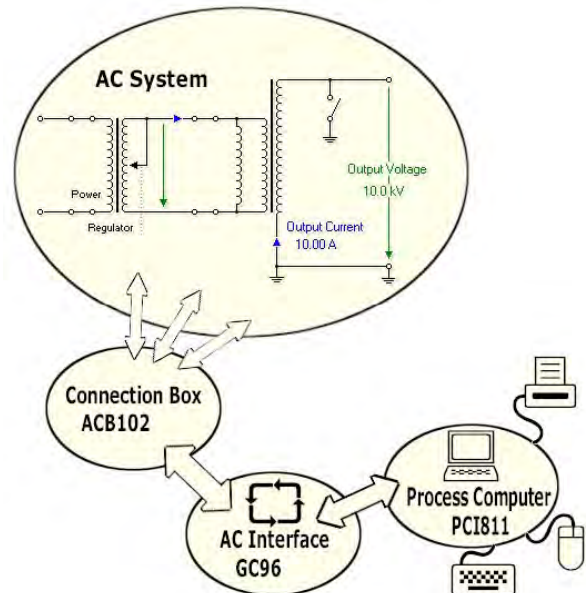

The front-end interface *Connection Box ACB102* is the interface to the AC test system itself. It is a standalone box situated close to the test transformer or resonance reactor and it collects the single control and measurement lines into 2 control cables. The connection box controls the front-end signals to the system, like: air gap motor, earthing system motors, etc.

The back-end *AC Interface GC96* is normally mounted in the mini rack of the control system. It monitors and controls the safety- & warning equipment and all other system parts. All analogue and digital signals from the AC test system are connected to this module. It matches the internal and external signal levels. It also filters the signals and removes interference from them.

Finally the Graphical User Interface (GUI) displayed on the flat screen of the operators desk – powered by the *industrial process controller PCI811* – features an easy, intuitive understandable and useable graphic surface, which is operated and controlled by mouse and keyboard.

TECHNICAL SPECIFICATONS

Mains input		
optional: 115 V		
Voltage	230 V	±10 %
Power	400 VA	
Frequency	50 / 60 Hz	
Fuses	6.3 A	ext. protected with 10 A
Isolation transformer	230 V / 230 V	1.5 kVA
Isolation voltage	4000 V	

Mains output		
Voltage	As for input	
Power	Max. 10 A	plugged
Fuses	No internal fusing	

Internal supplies		
+24 V	3.5 A	
+15 V	1.2 A	
-15 V	1.2 A	
+5 V	4 A	

Digital I/O		
Inputs	24 V	
Outputs	24 V	Short protected

Safety interlock and Customer-Specific I/O		
EMERGENCY off	9 poles male plug	AMP
Safety interlock	9 poles male plug	AMP
Warning lamps	9 poles male plug	AMP
High voltage measurement	BNC socket	AMP
Auxiliary input	9 poles male plug	AMP

Analogue I/O			
Inputs	0 ... 7 V	, 0 ... RMS	AC
	10 V P		
Inputs	0 ... 10 V		DC
Outputs	0 ... 10 V		DC

Operating Conditions	
Operating temperature	0 .. 40°C
Storage temperature	-20 .. 60°C
Humidity	20 .. 80 % r.h. non-condensing
Vibration	3g (IEC 68-2-6 xyz axis 10-150Hz)
Shock	10g (IEC 68-2-27 11ms half sine)

ORDERING INFORMATION

System	
Control system including:	OT257 AC

- PCI 811 industrial computer
 - GC96AC back-end interface
 - ACB102 connection box
 - All connection cables
 - Mini rack 12U
 - Operator desk
 - Emergency switch box and interlock
 - 15" TFT colour monitor
 - ASCII keyboard and mouse
 - Manual & Spare Part Set
- Basic control software package (installed)

Options	
Software tool "SEQUENCE" (programmable test sequences)	OT257SEQ
Software tool "REMOTE" (operation from a host PC)	T257REMOTE
Laser Printer	O OT-DRU

Modernizations
For upgrading or modernization of your AC test system please contact us for an offer and further details



Europe, Asia, South & Central America, Australia
Haefely Test AG
Birsstrasse 300
4052 Basel
Switzerland
☎ + 41 61 373 4111
☎ + 41 61 373 4912
sales@haefely.com

www.haefely.com
China (Sales & Service Office)
Haefely Test AG – Beijing Office
8-1-602, Fortune Street
No. 67, Chaoyang Road, Chaoyang District
Beijing, 100025
P. R. China
☎ + 86 10 8578 8099
☎ + 86 10 8578 9908
☎ sales@haefely.com.cn

North America
Hipotronics Inc.
1650 Route 22
PO Box 414
Brewster, NY 10509
USA
☎ + 1 845 279 3644
☎ + 1 845 279 2467
sales@hipotronics.com

a brand of

HAEFELY 



Haefely is a subsidiary of Hubbell Incorporated.

